

BOOMERAX Configuration Questionnaire

The new BOOMERAX series provides you with high precision device for XYZ manipulation. While the UHV [Boomerax XY-Manipulators](#) offer smooth and exceptionally precise 2-axis adjustment, the [Z-axis shift modules](#) provide large scale linear movements. Both can be combined with each other and/or with an additional rotary platform to set up a [complete XYZR manipulator](#). Motorized actuation is generally available optionally.

Both axis of the [Boomerax XY-Manipulators](#) can be limited mechanically for bigger feedthrough diameters. Short as well as long versions of the [Z-axis shift modules](#) have a continuous free bore, as the supports for their highest quality edge welded bellows are mounted externally.

Before answering the questions below, please refer to the configuration examples listed on our website www.ferrovac.com => Online catalogue and pricelist => Z-Manipulators/XY-Manipulators. Additional Information can be found at the end of this document.



Name and group:

I. Principal requirements

This table gives an overview of your demands. The main specifications will be shown in the respective sections.

	Axis	Continue with Section	Motorization preferred	Orientation
	XY Table	A		
	Z Drive	B		
	Rotary platform	C		

Please indicate which axis you'll need. The orientation is typically vertical or horizontal. Motorization is not available for all types, nevertheless please indicate if it is preferred or not of interest.

The details will be specified in the next parts.

II. Specification Section

A. XY-Table

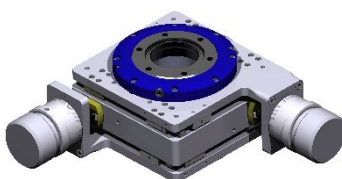

The BOOMERAX XY Series is available with three different bore sizes. The travel (in-plane) and mounting flange sizes depend on the bore. For an overview of the different combination possibilities please also see the section about the additional information. Be aware that the travel is also dependent on the insert size, which is indicated in the table.

Please indicate which clear bore is needed:

BOOMERAX XY SERIES SIZES & OPTIONS				
Travel [mm]	max. +/-10 (for inserts <19mm)	max. +/-12.5 (for inserts <40mm) (for inserts <77mm)		max. +/-25 (for inserts <52mm)
Clear Bore [mm]	39	65	102 (M,LS,LR,ENC)	102 (M,LS,LR,ENC)
Base-/Travel Flange DNCF	40/40-63	63-160/40-63	100-200/63-100	100-200/63-100
Indicate which bore and travel you need				

M=Motorisation, LS=Limit Switch, LR=Load Relief, ENC=Encoder

Which flange combination is needed?

Please mark the respective flanges needed by following the tree on the possible paths:
(Base and travel flange have tapped holes.)

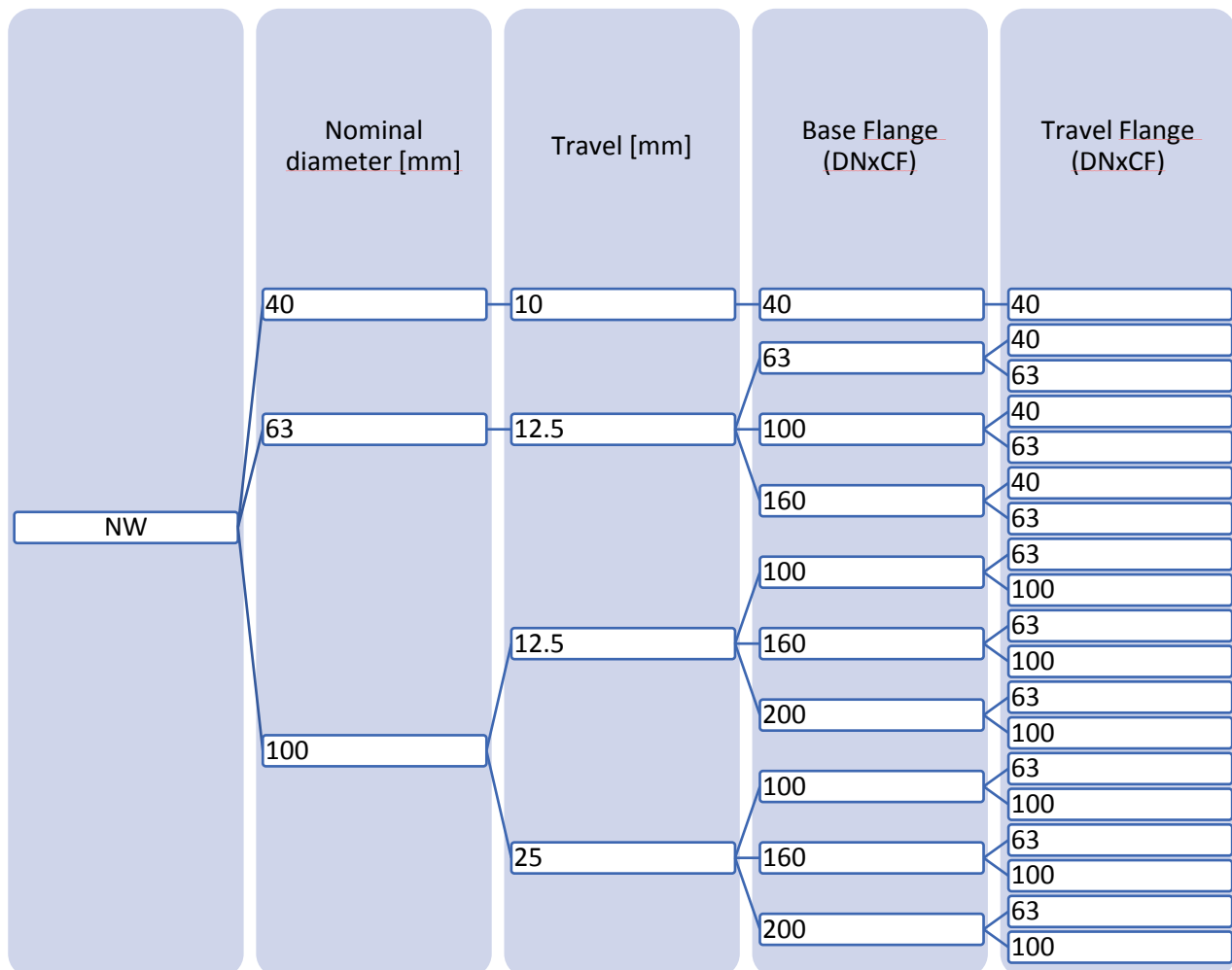

B. Z-Drive

The MZ drives can be used horizontally or vertically in different configurations. The travel length is limited according to the table below.

If a very specific custom length is needed, please contact us directly. Then length usually cannot be larger than the longest given in the table.



Please choose the respective sizes following the hierarchical paths and the flange options.

Customized lengths are possible as well. They should not be longer than the largest lengths given for the respective flange size.

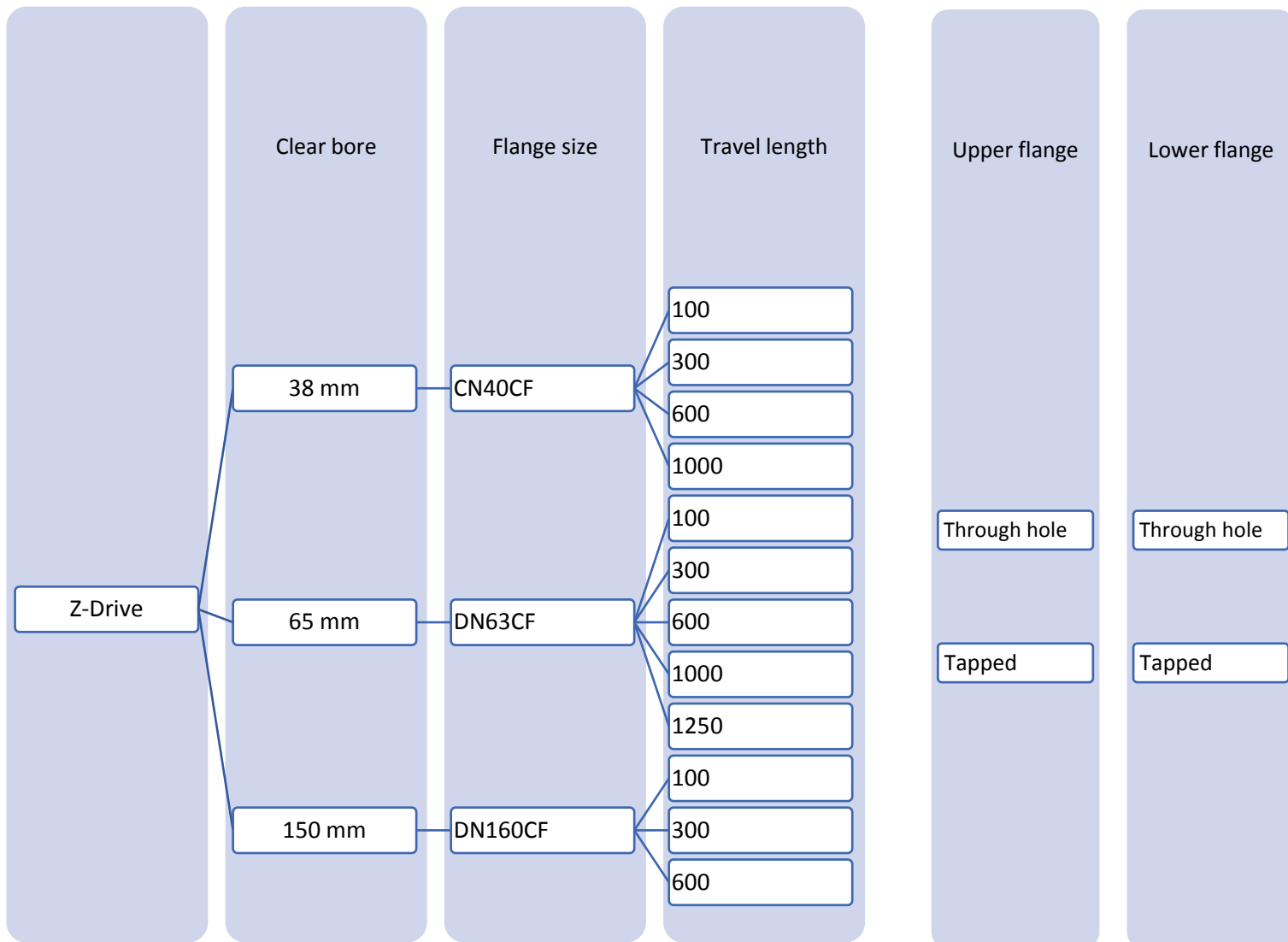

	Customized length needed (please specify)	mm
--	---	----

C. Rotary platform

Rotary platform needed

	DN40CF	DN63CF	DN160CF
Flange size needed			

	yes		no	
Motorization needed				
Type of motorization	DC motor		Stepper motor	
	yes		no	
Encoder needed				
Limit switches needed				

III. Upgrades and add-ons

A. XY – Tables

Motorization upgrades:

UPGRADEMXY100(+MOTMXYN23DC)	Motorization Kit for one axis of Boomerax-Series XY Manipulators. DC Motor 36V.
-----------------------------	---

UPGRADEMXY100(+MOTMXYN23)	Motorization Kit for one axis of Boomerax-Series XY Manipulators. Stepper Motor 2Nm with 1.8° step resolution.
---------------------------	--

UPGRADEMXY100(+MXENCLAK25)	Linear Absolute Optical Encoder Kit for X-Translator, 25mm Scale
----------------------------	--

UPGRADEMXY100CF100TCF63TX(+MXLIMELKIT)	One axis electrical limit switches for Boomerax XY Manipulators. Positions adjustable. Fully bakeable to 150°C
--	--



UPGRADEMXY100CF100TCF63TX(+MXYFS74)	Constant force spring, load relief upgrade for Boomerax XY Stage NW100, one axis
-------------------------------------	--

UPGRADEMXY100CF100TCF63TX(+MXYFS74)	-	Constant force spring with 74N load relief for one axis of Boomerax stage NW100 and NW63.	
-------------------------------------	---	---	---

UPGRADEMXY40CF40TCF40TX(+MXYFS22)	-	Constant force spring with 22N load relief for one axis of Boomerax stage NW40.	
-----------------------------------	---	---	---

B. Z-Drives

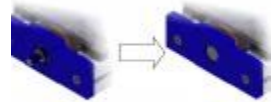

Motorization upgrades:





UPGRADEMZ(+MZENCLAK100)	Linear Absolute Optical Encoder Kit for Z-Translator, 100mm Scale		
UPGRADEMZ(+MZENCLAK300)	Linear Absolute Optical Encoder Kit for Z-Translator, 300mm Scale		
UPGRADEMZ(+MZENCLAK750)	Linear Absolute Optical Encoder Kit for Z-Translator, 750mm Scale		
UPGRADEMZ(MZLIMELKIT)	Electrical limit switches for Z-shift Manipulator. Positions adjustable. Fully bakeable to 150°C		
UPGRADEMZ(MOTMZ63T3)	Stepper Motor Kit for MZ Translators, Stepper Motor 3Nm with 1.8° step resolution		
MZCS-XXXX	XXXX= mm	Trimming of the MZ spindle overhead, length XXXX to be defined (in case of very strict height restrictions)	
MZS74	Support structure with constant force spring (74N) for X-axis of Boomerax Z-drives. Adjustable: 82N-156N		
MZS147	Support structure with constant force spring (147N) for X-axis of Boomerax Z-drives. Adjustable: 162N-320N		

Chamber accessories:

A couple of different small chambers to be placed on top of the Z-Drive are available, to add your feedthroughs and connections on the 5 x DN16CF tapped flanges.

Normal flanges with through holes, tapped flanges are indicated by a (T).

Code	Bottom flange	Top flange	Image
MZFCHCF63CF40T5XCF16T	DN63CF	DN40CF (T)	
MZFCHCF63CF40T5XCF16T30DEG (e.g. works well with the LN2 cooling option)	DN63CF	DN40CF (T)	

	MZFCHCF63CF40T5XCF16TH55	DN63CF	DN40CF (T)	
	MZFCHCF63CF635XCF16T	DN63CF	DN63CF	
	MZFCHCF63TCF63T5XCF16T	DN63CF (T)	DN63CF (T)	
	MZFDSCF63T5XCF16T	DN63CF (T)	-	

Cryo cooling accessories:

A liquid nitrogen cooled cryo table can be added to our Z-Drive as an insert with the chamber accessory MZFCHCF63CF40T5XCF16T30DEG and a readily usable tube system with VCR connections. At the end of the insert a cooling block is situated on which an individual sample receiver can be mounted.

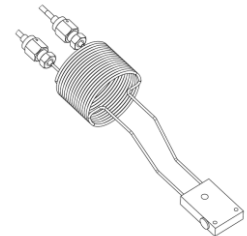

	Interest in the liquid nitrogen cooling kit insert
	A rotary feedthrough for (polar) sample rotation is needed

IV. Additional Information

A. XY-Table

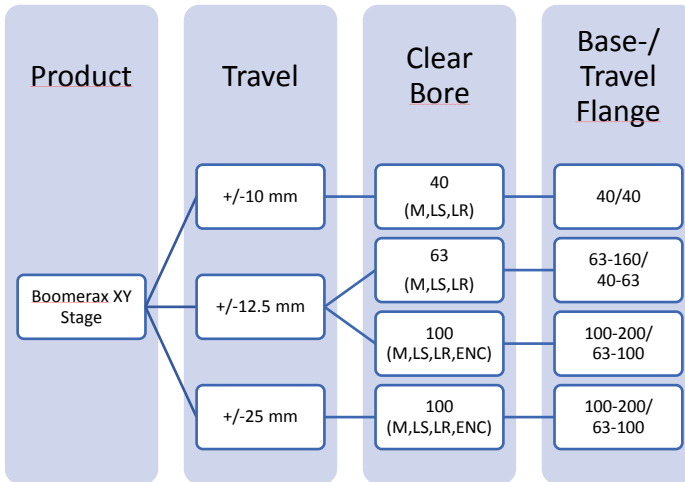

M=Motorization; LS=Limit Switch; LR=Load Relief; ENC=Encoder

Size examples for MXY63 and MXY40 tables respectively (dimension in mm):

MXY63CF63TCF63TX12

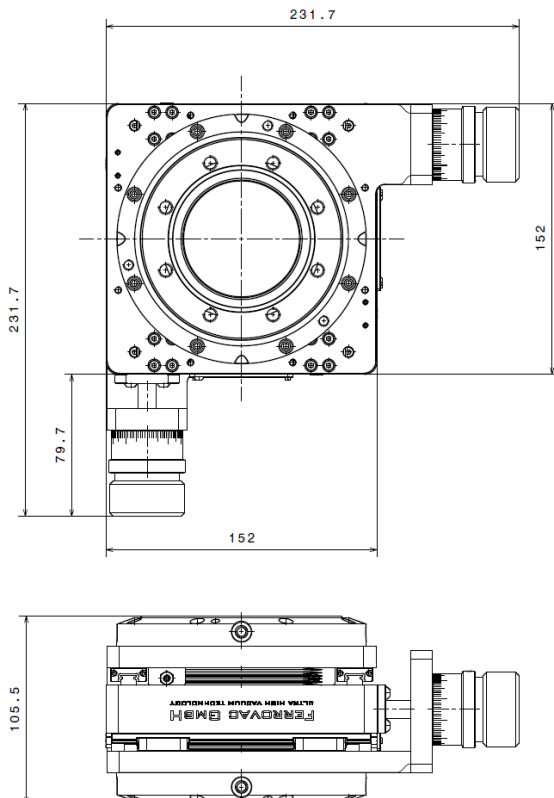

MXY40CF40TCF40XY7

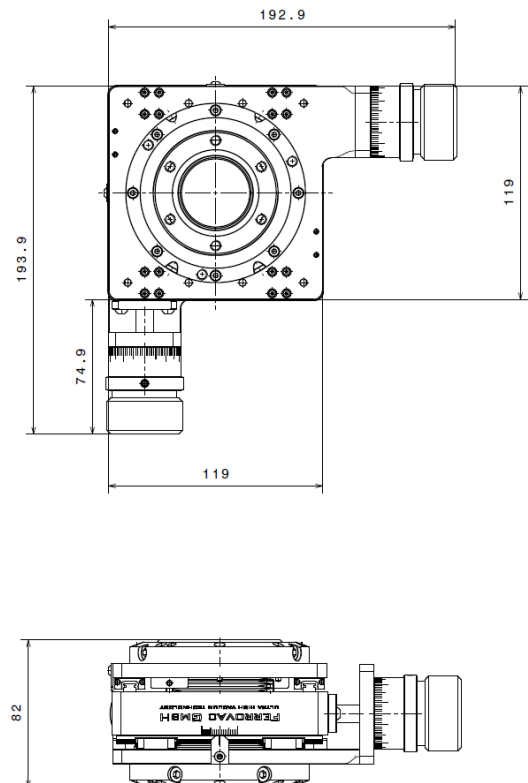

B. Z-Drive

Be aware that the hole position of the z-drive is fixed out-of-line. The flange orientation (rotation) cannot be changed, therefore the hole positions need to be taken into account when planning the system!

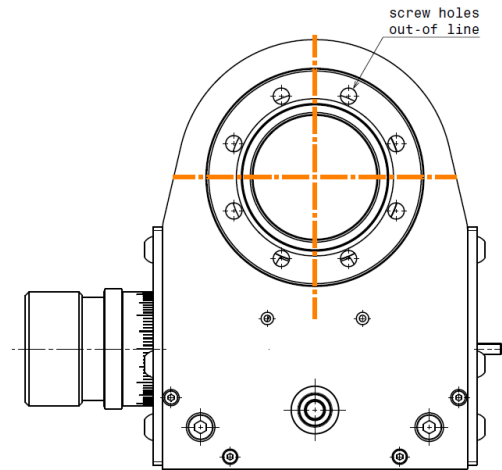

Size examples for MZ63 (dimension in mm):

Travel length	Length XXXX (see drawing)
100	282.25
300	521.95
600	861.7
1000	1361.9
1250 (max.)	1672.9

